

# Chapter 1

## Space-Based AIS with a Norwegian Small Satellite Constellation

Laura M. Bradbury<sup>1</sup>, Bjorn T. Narheim<sup>2</sup>, Jon Harr<sup>3</sup>, Bo Andersen<sup>3</sup>, Torkild Eriksen<sup>4</sup>, Øystein Olsen<sup>4</sup>, Øystein Hellenen<sup>4</sup>, Richard Olsen<sup>4</sup>, Daniel D. Kekez<sup>1</sup>, Alex M. Beattie<sup>1</sup>, and Robert E. Zee<sup>1</sup>

<sup>1</sup>Space Flight Laboratory, University of Toronto Institute for Aerospace Studies  
4925 Dufferin Street, Toronto, Ontario, M3H5T6, Canada

<sup>2</sup>Narheim - Microspace Consultant (NAMICO)  
Skjetten, Norway

<sup>3</sup>Norwegian Space Agency  
Drammensveien 165, N-0277 Oslo, Norway

<sup>4</sup>Norwegian Defence Research Establishment (FFI)  
P.O. Box 25, N-2027 Kjeller, Norway

### 1.1 Introduction

In recent decades, small satellites have become capable of increasingly valuable missions to demonstrate emerging technology and applications. Together with shorter development cycles, the reduction of launch costs, and operational resiliency in the event of failure, small satellite constellations offer an attractive way of establishing national expertise in space technology. The Norwegian AIS (Automatic Identification System) small satellite constellation was initiated based on national needs for better monitoring of ocean areas under Norwegian jurisdiction, which amount to more than two million square kilometers.<sup>1</sup> With this goal in mind, the first satellite, AISSat-1, was initiated in 2007 and subsequently launched in July 2010 as a service demonstrator.<sup>2</sup> It is a nanosatellite designed by the Space Flight Laboratory (SFL) and carries an AIS receiver for collecting transmissions from vessels, containing information such as identity, position and heading, on dedicated frequencies in the maritime VHF band (156.025-162.025 MHz).

Since this receiver was put into space in 2010, satellite AIS has become a recognized system for maritime vessel traffic monitoring and safety. In addition to the Norwegian initiatives, other pioneering organizations, such as Orbcomm, SpaceQuest, LuxSpace and COM DEV, contributed to satellite AIS development starting in the early 2000s.<sup>3</sup> In order to extend Norway's maritime surveillance capability two copies of AISSat-1, AISSat-2 and AISSat-3, were ordered and

launched in July 2014 and November 2017, respectively. Unfortunately, AISSat-3 never reached orbit due to a launch failure. The latest additions to the AIS constellation are NorSat-1 and NorSat-2, which were both launched in July 2017 from the Baikonur Cosmodrome. The main payload on all satellites is an AIS receiver, which is an in-orbit reconfigurable software-defined radio developed by Kongsberg Seatex. NorSat-1 and NorSat-2 carry an upgraded version which has a more sensitive receiver capable of detecting significantly more ships than its precursor. The data collected by these satellites is used by the Norwegian Coastal Administration (NCA) and other authorities to manage the national waters by monitoring fisheries, oil spills, and maritime traffic.

Over the past couple of decades, small satellites have evolved from demonstrators to operational assets to enable low cost space access for government services and commercial service providers. The Norwegian AIS constellation is an example of how small satellites have revolutionized global ship traffic monitoring, and how a satellite program grows from a single payload on nanosatellites to multiple payloads exploring new science as well as new maritime services on microsatellites. This chapter discusses the Norwegian satellite missions, with an emphasis on the unique and innovative aspects that made spaced-based AIS extremely valuable and of long-term strategic importance to Norway.

## 1.2 History of Space Initiatives in Norway

The space age in Norway commenced with the first sounding rockets from the Andøya Rocket Range in 1962. However, the major investments from the government started with Norway entering into the European Space Agency (ESA) in 1987. Since then the Norwegian priorities have primarily been based on participation in international projects through ESA, NASA and the European Union. In 2018, about 90% of the government's space investments were in international collaboration. Norway has the opinion that in space, all countries are small. That is, few nations have the economic or technical capability to cover all its space needs. Norway's priority is built on creating competitive industries and catering for central societal needs. Space is a tool to achieve this, not a goal in itself.

The strong emphasis on sounding rockets early on made Norway well aware of the capabilities that could be built up in niche areas. This awoke the Norwegian space community to the opportunities of the small satellite revolution in the eighties. The Norwegian Space Agency (NoSA) and its main scientific partners therefore attempted to get support for a geo-space science mission in the early nineties, but there was no political support for this. An initiative from the Norwegian Defence Research Establishment (FFI) came to a similar fate in the early 2000s. FFI wanted to build a microsatellite with the capability to detect navigational radar from ships.<sup>4</sup> It was not possible to get support for national efforts on small satellites in parallel with what the government saw as large investments in ESA. The industrial case could not be made.

By 2006 it was clear that the government would not give priority to a national small satellite program, neither on industrial terms nor based on user needs. But in spite of this the NoSA, based on a proposal from FFI, took the initiative to begin the development of what would become Norway's first small satellite, AISSat-1. Here the focus was on space being the necessary tool for Norwegian authorities to achieve the high-priority goal of understanding and surveillance of the maritime traffic in the oceans around Norway.

Norway manages economic and fisheries ocean zones with a total extension of more than two million square kilometers, which is more than six times larger than the mainland (Fig. 1-1).<sup>5</sup> In this body of water, Norway needs to manage natural resources, carry out search and rescue missions, and safeguard sovereignty. Ships larger than 300 gross tons are required to carry AIS transponders,<sup>6</sup> which transmit vessel name, position, speed and course.<sup>7</sup> However, AIS messages are only received by coastal stations if the ship is within 40 nautical miles of the coastline, leaving large areas of ocean unmonitored.<sup>8</sup> In

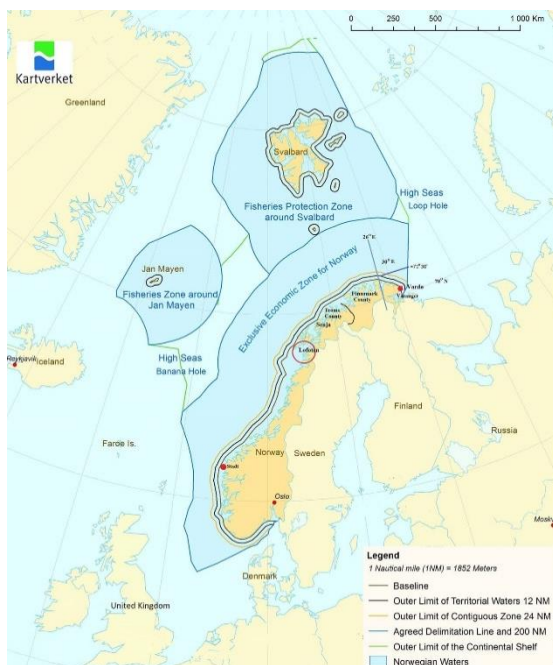

**Fig. 1-1. Ocean and coastal areas under Norwegian jurisdiction.<sup>5</sup>**

cooperation with the NCA and FFI, the NoSA ensured the development of an operational system of AIS satellites capable of tracking vessels outside of the coverage areas of land-based systems.

It was immediately clear that the costs would be prohibitive if Norwegian industry should develop and build the satellite platform. The choice was made to focus on payload development and acquire the platform from companies that had made the initial development and had success in space with previous missions. Following a tender process, the choice fell on the Space Flight Laboratory (SFL) at the University of Toronto Institute for Aerospace Studies (UTIAS). All of this was done within the existing budgets of the NoSA and FFI. The Norwegian Coastal Administration was brought in as the end user, they but did not contribute economically.

### 1.3 Space Flight Laboratory

SFL has a long history in building, launching, and operating low-cost small satellite missions. Since its establishment in 1998, SFL has successfully launched 25 satellites, including the first Norwegian satellites. Satellite missions are handled by a small team of people. With a full-time staff of professionals, SFL is able to provide a full range of services and products needed to implement low cost, rapidly-deployed small satellite missions, from mission conception through launch and on-orbit operation. SFL has extensive experience in developing on-board computer hardware, radios, antennas, attitude control, power systems, propulsion, and payloads for six classes of small satellite platform that SFL offers: THUNDER (3U), GRYPHON (Generic Nanosatellite Bus or GNB), NEMO, DEFIANT, NAUTILUS, and DAUNTLESS (Fig. 1-2). The specifications listed for the platforms are typical mass, volume, and power numbers, rather than constraints. The platforms can be scaled up or down depending on the particular mission requirements.

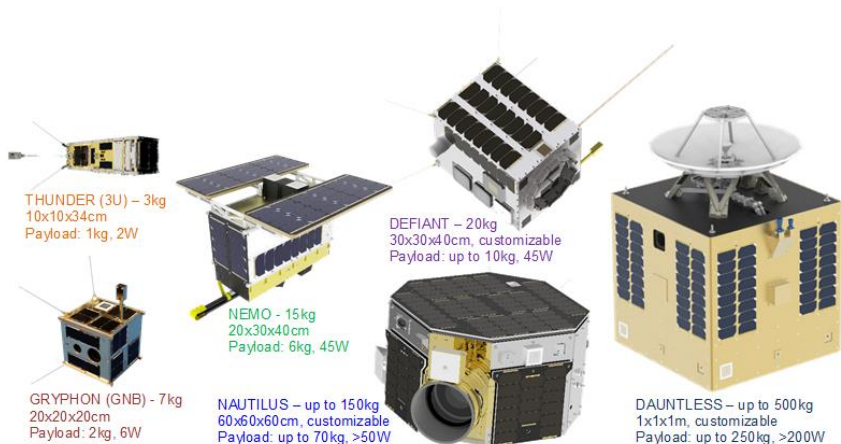

**Fig. 1-2. SFL microsatellite platforms.**

The first Norwegian satellite that SFL designed and launched was AISSat-1, which was based on the GNB platform. It has a 20 cm cubic form factor and its mass is approximately 7 kg. Due to the success of the mission, SFL was commissioned to build two additional AISSat satellites, AISSat-2 and AISSat-3, that were nearly identical to AISSat-1. These nanosatellites were highly successful especially with the limited platform mass, volume, and power resources. The NoSA decided to explore new capabilities in science as well as maritime applications, and the next microsatellites in the Norwegian constellation used the Next-generation Earth Monitoring and Observation (NEMO) platform, which is slightly larger than the GNB. These are NorSat-1 and NorSat-2. The satellite platforms the Norwegian constellation has used are described in the next

couple of subsections, followed by detailed descriptions of the Norwegian missions.

### 1.3.1 Generic Nanosatellite Bus (GNB) Platform

SFL began the development of the GNB platform around 2005 with the intention of creating a nanosatellite platform that would readily accommodate a wide variety of mission requirements with only minimal mechanical and electrical changes necessary between missions. The GNB platform is one of the smaller satellite platforms and was historically the workhorse for many of SFL's missions, including the BRITE (BRiGht Target Explorer) Constellation<sup>9</sup> and the CanX-4 and CanX-5 formation flying mission.<sup>10</sup>

The GNB is classified as a nanosatellite, with a mass around 7 kg. The primary satellite structure is aluminum in an approximately  $20 \times 20 \times 20$  cm form factor. There are three onboard computers, responsible for payload control, ground communication, data storage, and managing a suite of attitude sensors and actuators. The attitude sensors and actuators are comprised of six sun sensors, a three-axis magnetometer, a rate sensor, three reaction wheels, and three magnetorquers. The AISSat satellites employ a 4 kbps UHF receiver for command uplink, and for telemetry downlink an S-band transmitter capable of rates up to 2 Mbps. A GPS receiver is included to support precision onboard timing for the AIS receiver and orbital position knowledge. A centralized power system allows load switching and provides voltage supplies to loads. The bus and solar array voltage is regulated using a Battery Charge and Discharge Regulator (BCDR), which is integrated with an 18 W-h Lithium-ion battery. The system architecture of the satellite is shown in Fig. 1-3.

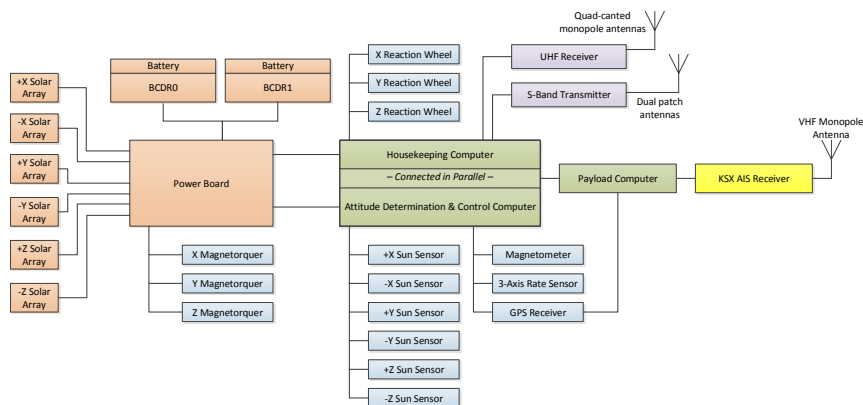
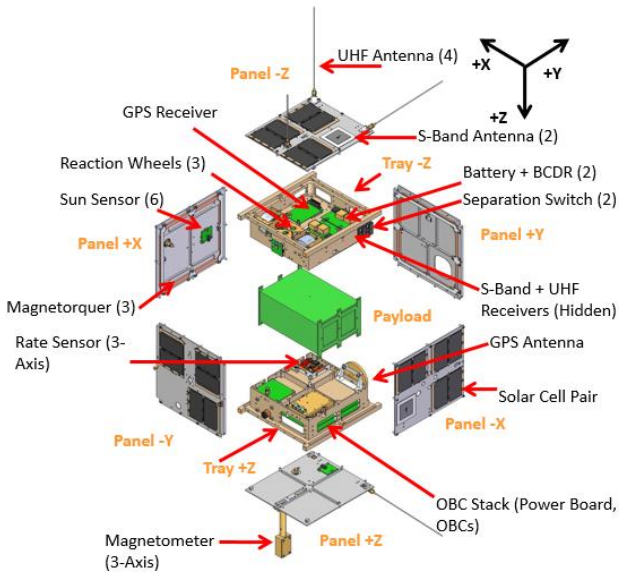

Fig. 1-3. AISSat system architecture.

#### 1.3.1.1 Structural Design Overview

The GNB structure has two main trays and six exterior panels shown in Fig. 1-4, in an exploded solid model with all main components highlighted. The main

trays are the structural backbone of the satellite and are used to mount the majority of the satellite avionics. The trays are at opposing sides of the satellite (+Z and -Z), leaving a large central volume between them for the payload. Once the trays and payload are fully integrated, the structure is completed with six aluminum panels that provide additional structural support since they are 2 mm thick with interior cross-braces to reduce deflection. The panels are also used to mount components external to the satellite, such as antennas and solar cells.



**Fig. 1-4. GNB satellite primary structural components.**

For the AISSat satellites, only minor changes were made to the GNB platform to accommodate payload-specific components, thus highlighting the adaptability of the GNB to a variety of missions. The AISSat satellites have one, linearly polarized VHF antenna that is mounted to a load bracket secured between the trays. A cutout in the -Y panel allows the antenna to be detached and reattached without any disassembly of the satellite. The solid model of AISSat-1 is illustrated in Fig. 1-5.

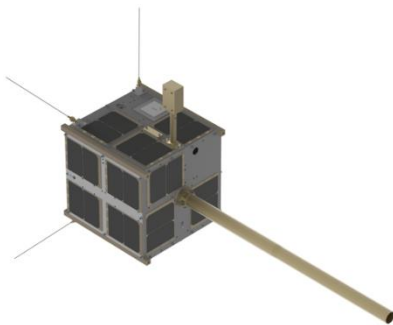

**Fig. 1-5. AISSat-1 external solid model.**

The thermal control of the GNB is almost entirely passive and is designed to keep components within their respective operational thermal envelopes while powered, and within their survival thermal envelopes otherwise. The satellite relies on a selection of thermal tapes that are bonded to the available surface area of the

external panels. The tapes are selected based on their thermo-optical properties and their application area is tailored based on the expected orbit and satellite attitude in order to control the temperature swings. Furthermore, the internally-mounted satellite components are tailored by material selection and heat path geometry design across their respective mounting surfaces. The only active thermal control measure present on the GNB are the resistive heaters present on the spacecraft batteries that are turned on if the battery temperature falls below 10°C.

### *1.3.1.2 Telemetry and Command*

The main function of the communication subsystem is to provide reliable communication between the satellite and the ground for the purposes of commanding, collecting telemetry and housekeeping data, and supporting payload functions. The GNB design uses UHF-band frequencies for command uplink, and S-band frequencies in the space operations and research band for both telemetry and payload data downlink.

The downlink is controlled by a custom-designed S-band transmitter from commercial off the shelf (COTS) components. Its data rate and modulation can be scaled on-the-fly from 32 kbps to 2048 kbps. Scaling is automatically executed by ground software as the link with the Earth station improves and deteriorates throughout the pass. The antenna system used for the downlink is an omnidirectional pair of probe-fed RHCP patch antennas bonded to opposing satellite faces.

### *1.3.1.3 Attitude Determination and Control Subsystem*

The Attitude Determination and Control Subsystem (ADCS) is responsible for estimating the satellite's attitude state and commanding the actuation autonomously towards a desired state.<sup>11</sup> The ADCS may be broken down into three segments: attitude determination hardware, attitude control hardware, and software processing.

The attitude determination sensors are comprised of a three-axis magnetometer, six sun sensors, and a three-axis rate sensor, which are all designed and built at SFL. Actuation is provided by three orthogonal reaction wheels and three orthogonal vacuum-core magnetorquers. The reaction wheels are used for fine pointing control and the magnetorquers are used mainly for reaction wheel desaturation. A GPS receiver is present onboard for orbital position knowledge and precise timing. The receiver is connected to the onboard computers, which allows the computers to synchronize their clocks with the GPS receiver clock. A GPS antenna is mounted to an external satellite panel.

The ADCS algorithms are implemented by SFL's Onboard Attitude System Software (OASYS), which takes in measurements from sensors and compares these with models that are propagated in time to estimate the attitude and orbital states using an Extended Kalman Filter (EKF). Sensor-corrected estimates of the body rates, attitude, orbital position, and orbital velocity are produced by the

filtering process, which is fed into the OASYS' control algorithms. These algorithms compare the filtered, or estimated, attitude and orbital states with the desired state, and subsequently calculate the torques and wheel speeds necessary to achieve the desired condition.

The ADCS can operate in several control modes that are described in Table 1-1. Three-Axis Control is the primary operational attitude mode throughout the course of the mission and can be used in several different sub-modes, including limb pointing and ground target tracking. Ground target tracking is used for passes over the Earth station, whereby the spacecraft tracks a static target on the ground with a specified body axis while a second body axis is constrained to a second desired axis.

**Table 1-1. Overview of ADCS control modes.**

|                    | <b>Description</b>  | <b>Active Sensors/Actuators</b>  |
|--------------------|---|--|
| Safe               | The default state when the satellite is separated from the launch vehicle. No determination or control performed.   | None   |
| Passive            | Only attitude and rate estimation is performed. No control is calculated or applied.  | Sun sensors, rate sensor, magnetometer   |
| Rate Damping       | Damps launch vehicle tipoff rates or if the satellite has excessively large body rates. B-dot control law generates a magnetic dipole of which interacts with the Earth's magnetic field to produce torques to counter the spin of the satellite. | Magnetometer, magnetorquers  |
| Three-Axis Control | Inertial or target pointing with a control error of less than $5^\circ$ ( $2\sigma$ ) in sunlight. Typically operated in sun-pointing, where the largest power generation surfaces are oriented towards the Sun.                                  | Sun sensors, rate sensor, magnetometer, GPS receiver, reaction wheels, magnetorquers |

Momentum management is performed in parallel with active control tasks and can be enabled or disabled as necessary. The desired satellite inertial angular momentum is entered as a setpoint, and the magnetorquers are actuated to regulate the wheel speeds while simultaneously holding the desired attitude.

#### *1.3.1.4 Command and Data Handling Subsystem*

The Command and Data Handling (C&DH) subsystem is responsible for configuring the payload and managing certain payload data. This is in addition to the standard C&DH functions: gathering bus telemetry, routing communications packets, and executing attitude control. To provide all this functionality, the satellite includes three onboard computers (OBCs). Each OBC contains 1 GB of flash memory and runs on an ARM7 processor with a clocking frequency of 40 MHz while running application software. The hardware for each OBC is the same but they are designated based on their function. A housekeeping computer



(HKC) is responsible for overall housekeeping tasks of the spacecraft, including collection and logging of telemetry and routine communication between the spacecraft and the Earth station. An attitude determination and control computer (ADCC) is responsible for all activities related to the attitude determination and control subsystem. The HKC and ADCC are cross-connected to all bus hardware, allowing their functionality to be swapped or combined onto a single OBC, therefore providing redundancy. The third OBC, a payload onboard computer (POBC), is responsible for interfacing with the payloads.

The computer system software implements a two-level approach. The first level of software, the bootloader, is intended to implement only simple, basic functions. Bootloader functionality includes basic ground-requested communication, both with the ground and between units, ground-requested telemetry gathering, and the ability to write new application software into onboard flash memory. The second level is the application software. This software is comprised of a custom-designed real-time operating system called the Canadian Advanced Nanosatellite Operating Environment (CANOE) upon which the housekeeping tasks and attitude software are executed.

#### *1.3.1.5 Electrical Power Subsystem*

The power system for the GNB platform implements a fully-regulated direct energy transfer (DET) bus with peak power tracking (PPT) functionality.<sup>12</sup> A single Battery Charge/Discharge Regulator (BCDR) is used to set the operating voltage of the solar array and bus, regulate battery current, and monitor telemetry, such as voltage, current, and temperature. The GNB power board serves as a central power distribution and regulation board, interfacing with the solar cells, the BCDR, the onboard computers, and the remainder of the hardware in the satellite. The power board houses the power electronic components implementing the regulation of point-of-load voltages and controlling the switches providing power to all units on the satellite.

Solar arrays are mounted to all the exterior body panels, each of which generates approximately 5.7 W under worst-case hot, end of life (EOL) conditions. The solar cells are triple junction GaInP<sub>2</sub>/GaAs/Ge solar cells with a beginning of life (BOL) efficiency of 26.8%. The solar cells are protected by an integral bypass diode.

The satellite uses two redundant Lithium-ion batteries for energy storage. The battery is mounted directly to the BCDR which implements the spacecraft's peak power tracking capability by setting the voltage on the solar arrays and the satellite bus. The BCDR is designed to monitor and regulate the battery current, voltage, and temperature during charge and discharge.

### **1.3.2 Next-generation Earth Monitoring and Observation (NEMO) Platform**

The development of the NEMO platform came subsequent to the successful GNB to address greater mass, volume, and power requirements from the

payloads.<sup>13</sup> At 15 kg and more than double the volume, the NEMO platform enables SFL to integrate and simultaneously operate multiple payloads within a microsatellite platform, with each payload satisfying different mission objectives. Much of the core avionics was derived from the flight-proven GNB, however new design and development took place with various subsystems, specifically the power system and the radios. These differences are described in the sections that follow.

### 1.3.2.1 Structural Design Overview

Like the GNB, the NEMO platform is built around a robust dual-tray concept, which houses subsystem components in a convenient layout that facilitates rapid integration and testing. The trays are then enclosed with structural panels that provide a mounting area for attitude sensors, solar cells, antennas, and any other necessary components. NorSat-1 and NorSat-2 are structurally very similar, and the main structural components of NorSat-2 are shown in Fig. 1-6. Each has a central bus structure, with outer dimensions of  $440 \times 200 \times 267$  mm, which houses the avionic and payload components. They have two pre-deployed solar array wings to extend power generation capabilities. NorSat-1 has an overall mass of 15.6 kg, and NorSat-2 is 16.0 kg.

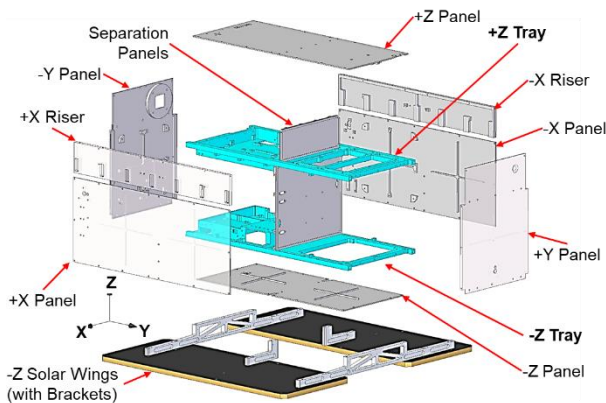

**Fig. 1-6. NorSat-2 structural components.**

The microsatellites use primarily passive thermal control, relying on thermal tapes to maintain the necessary temperatures. The typical range of environmental conditions is between  $-20^{\circ}\text{C}$  and  $60^{\circ}\text{C}$ . Active thermal control is only present for the batteries in that they have heaters that turn on under certain cold conditions.

### 1.3.2.2 Telemetry and Command

On the NEMO platform, both UHF and S-band radios are supported; however, both NorSat-1 and NorSat-2 use S-band for uplink and downlink. In addition to the regular telemetry and command uplink and downlink system, NorSat-2 also has an enhanced S-band feeder uplink.

The telemetry and command S-band uplink consists of a combiner, a band pass filter, a downconverter, and a UHF receiver. The S-band uplink forms the method with which commands are sent to the spacecraft for all mission functions, and therefore must be active at all times. Two patch antennas bonded to opposing satellite faces are used to provide omnidirectional coverage.

The high-speed S-band feeder uplink is another custom-designed board capable of achieving uplink speeds of up to 1 Mbps. The purpose of including the separate feeder uplink is to support VHF Data Exchange System (VDES) operations on NorSat-2. It is intended to allow the upload of large waveform files to the VDES payload. The S-band feeder uplink has a single patch antenna, bonded to the +Z face of NorSat-2.

### *1.3.2.3 Electrical Power Subsystem*

The electrical power system provides a continuous and reliable power supply to the spacecraft using a series peak power tracking topology called the Modular Power System (MPS). The functionality of the MPS is divided into interchangeable cards located on a passive backplane. The power systems on NorSat-1 and NorSat-2 are capable of producing 48 W of generated solar power and can store approximately 108 W·h using a single 3-series, 2-parallel Lithium-ion battery pack. The battery is connected to the power system through the Battery Interface Module (BIM), which provides battery protection and monitoring capabilities. There are two pre-deployed solar wings, containing a total of 64 solar cells, and 1-2 body-mounted 8-cell solar strings on each satellite face for safehold power generation. The cells used are GaInP<sub>2</sub>/GaAs/Ge triple junction solar cells with a slightly higher BOL efficiency of 30%. Each cell is 40 × 80 mm in size and is equipped with an integrated bypass diode.

## **1.4 AISSat-1, AISSat-2 and AISSat-3**

AISSat-1 is the first satellite based on the GNB platform to be launched and we believe it be the first high-performance nanosatellite to provide an observational service to government authorities.<sup>2</sup> It carries an ASR 100 AIS space receiver payload, which is a software-defined radio (SDR) from Kongsberg Seatex. The AIS signal is sampled and forwarded to a field programmable gate array (FPGA) for further hardware processing. The radio covers the entire maritime VHF band, but is nominally tuned to 161.975 MHz (AIS1) and 162.025 MHz (AIS2). The ASR 100 has significant on-orbit heritage, as it was also installed onboard the International Space Station (ISS) as the NORAIS Receiver of the Vessel ID System, as well as launched as a commercial payload on other missions.



**Fig. 1-7. AISSat-1 fully assembled in the SFL cleanroom.**

AISSat-1 is designed to have two basic observation modes: bent pipe and store-and-forward. The first mode, bent pipe, is applicable when the satellite is in contact with the Earth station and AIS messages received from vessels located in the satellite's field of view are directly forwarded to the Earth station with a latency of less than one second. This mode enables Norwegian authorities to have a real-time picture of the maritime area around Norway where the Earth station is located. The store-and-forward mode on AISSat-1 enables the satellite to receive AIS messages from ships around the world which are stored in flash memory and later

downlinked to the Earth station when it is in view.

AISSat-1 was a pathfinder mission; the success of this nanosatellite led to significant further development of the Norwegian maritime satellite constellation. On July 8, 2014, AISSat-2 was launched, enhancing the overall revisit frequency, increasing coverage, and providing redundancy for space-based AIS observation for Norway. AISSat-2 is, for the most part, identical to AISSat-1 and incorporates all the improvements made to the AISSat-1 design following its launch.

A third similar satellite, AISSat-3, also based on the GNB platform, was developed to complete the constellation. It contained an improved AIS space receiver (ASR 300) from Kongsberg Seatex in addition to upgraded onboard computer software and an improved S-band transmitter capable of faster downlink rates. Unfortunately, AISSat-3 never reached orbit due to a launch failure in November 2017. However, the ASR 300 operates as the NORAIS-2 Receiver on the ISS, and experience from that has been used in the development of the state-of-the-art ASR x50 AIS space receiver.

## 1.5 NorSat-1

AISSat-1 and AISSat-2 provided the Norwegian government with valuable data and greatly enhanced maritime awareness, particularly in remote regions. However, the next satellites in the constellation would require more mass, volume, and power for an improved AIS receiver and auxiliary payloads, both of which drove the decision to go with a larger bus. Therefore, the satellite bus selected for the NorSat platform was the space-proven, cost-effective, and modular NEMO microsatellite platform.

NorSat-1 is a microsatellite integrating three diverse payloads. It carries an AIS receiver and two scientific payloads: (1) a multi-Needle Langmuir Probe (m-NLP) to study ambient space plasma characteristics and a Compact Lightweight Absolute Radiometer (CLARA) to study the total solar irradiance (TSI). Fig. 1-8 highlights the payloads of NorSat-1 on the diagram of the external solid model.

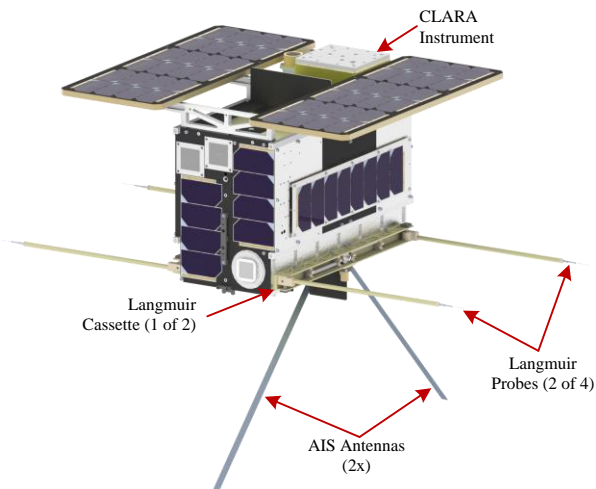
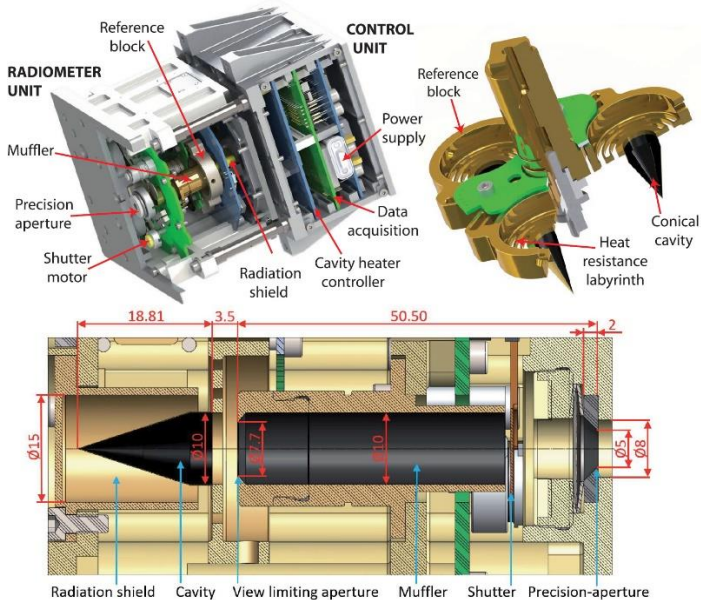

**Fig. 1-8. NorSat-1 external solid model.**

The ASR x50 AIS space receiver is the fourth generation satellite AIS receiver from Kongsberg Seatex. It is a reconfigurable SDR-based receiver that is designed to support simultaneous onboard AIS decoding and digital sampling. The ASR x50 has an improved RF front end and a larger FPGA than the previous generations of AIS receiver. It enables multi-channel reception and simultaneous reception of the original AIS messages as well as the long-range messages that were introduced on two new channels in version 4 of the standard.<sup>7</sup> The receiver supports up to four antennas on each AIS channel and has multiple advanced demodulators, which increases the reception performance compared to previous generations. For AIS reception, NorSat-1 accommodates two linearly-polarized tape-spring monopole antennas in an orthogonal configuration. The antennas are held down while the satellite is in its separation system and deployed automatically upon ejection.

The multi-Needle Langmuir Probe (m-NLP), developed by the University of Oslo, makes use of four needle probes of 0.51 mm diameter and 25 mm length. A Langmuir probe works by placing an exposed conductor in a plasma, biasing it to a reference potential relative to the plasma potential, and measuring the collected current. The probes on NorSat-1 are sampled simultaneously (up to 1 kHz), which allows the spatial electron density to be determined down to a few meters without knowledge of electron temperature or spacecraft potential.<sup>14</sup> The primary goal of the m-NLP instrument is to identify and quantify the mechanisms that cause the generation of small-scale ionospheric plasma density structures.

CLARA, built by the Physical Meteorological Observatory Davos and World Radiation Center (PMOD/WRC) in Davos, Switzerland, is an electrical substitution radiometer (ESR) that measures the total solar irradiance (TSI) (Fig. 1-9).<sup>15</sup> It is based on a new three-cavity design, which offers built-in redundancy and degradation tracking capability. The goal of CLARA is to measure the TSI with an uncertainty better than  $0.4 \text{ W/m}^2$  on an absolute irradiance level. Pointing requirements for CLARA are stricter than the AIS payload. It requires a pointing accuracy of  $\pm 0.5^\circ$  ( $3\sigma$ ) where the centre of the CLARA field of view is aligned with the centre of the sun. This is possible with the use of the high-fidelity sun sensor that is present on NorSat-1.



**Fig. 1-9. Schematic of CLARA showing various parts of the instrument.**<sup>15</sup> (Image courtesy of PMOD/WRC.)

## 1.6 NorSat-2

The growing demand for maritime data services led the International Association of Lighthouse Authorities (IALA) to develop a new VHF Data Exchange System (VDES), included on NorSat-2, that will provide two-way communication at higher data rates than possible with current AIS systems. Within the VHF maritime frequency band, VDES integrates AIS with channels for Application Specific Messages (ASM) to support the distribution of maritime data, including meteorological and hydrographic data and traffic information. Expanding VDES to a multi-satellite network will facilitate a global data exchange between ships and shore via satellite.

NorSat-2 carries the ASR x50 space receiver as main payload and an experimental payload for demonstration of a new VHF Data Exchange System (VDES) satellite component (VDE-SAT). The functional system design of the VDES transceiver was done by Space Norway AS, while the detailed design and manufacturing was assured by Kongsberg Seatex. SFL developed the novel antenna solution. The complete experiment was implemented and is operated by Space Norway AS, partly under ESA funding. Like the AIS space receiver, the VDE-SAT payload is an SDR with transmission and reception capability. The VDE-SAT in-orbit demonstration, which is supported by ESA and the International Association of Lighthouse Authorities (IALA), aims to demonstrate the feasibility of a VHF data exchange protocol via satellite to ships, which could eventually open a new way of transmitting high-priority maritime information such as weather data, navigational routes, and sea ice predictions.<sup>16</sup>

The maritime industry is digitizing most aspects of ship operation and the coastal administrations are developing a new VDES data communications system. VDES was proposed to address indications that the VHF Data Link (VDL) of AIS was being overloaded and to enhance data exchange for e-navigation. The VDES will be the data carrier for the e-Navigation Maritime Service Portfolios identified by IMO that will provide digital information for safety and security at sea and protection of the marine environment, as well as commercial services.

The ITU Radiocommunication Sector (ITU-R) released the first version of the standard, ITU-R M.2092-0, in 2015.<sup>17</sup> The World Radiocommunication Conference in 2015 (WRC-15) allocated frequencies for the terrestrial segment of VDES and released considerations of regulatory provisions and spectrum allocations to enable the satellite component of VDES.<sup>18</sup> The VDES satellite component operates in the relevant part of the VHF maritime frequency bands 156.0125-157.4375 MHz and 160.6125-162.0375 MHz. The VDES functions and frequency usage is depicted in Fig. 1-10.

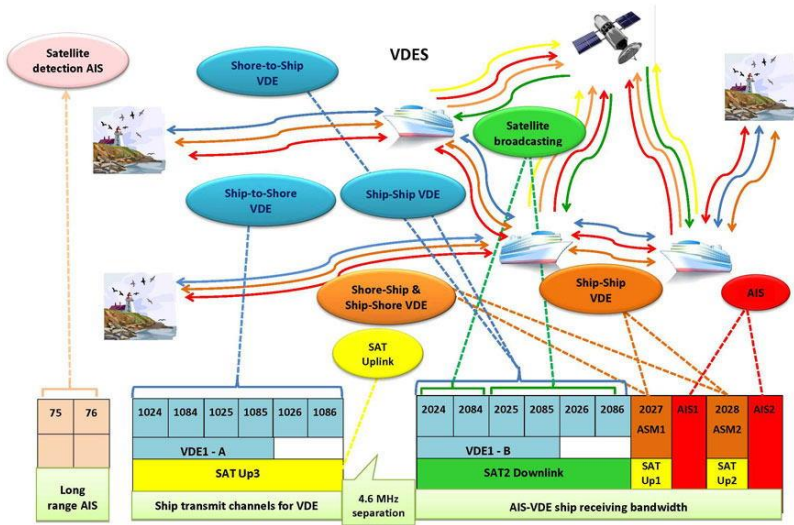

Fig. 1-10. VDES functions and frequency usage.<sup>17</sup>

VDES therefore supports terrestrial communications between ships and stations on the shore, whilst satellite communications is envisaged far from shore and particularly in the Arctic regions outside geostationary satellite coverage. The WRC-15 recognized that the VDES satellite component is necessary to expand the system from coastal coverage to global coverage, and recommended that studies should be carried out with the VDES satellite component in order to decide on the future of satellite VDES at the next conference, WRC-19.

NorSat-2 has an experimental two-way software defined VDES transceiver and will be used to develop propagation models and to demonstrate wide-area services such as Arctic ice chart distribution and notices to mariners. Two-way electronic navigation services are envisaged later when the standard is fully defined.<sup>19</sup> It is expected that future ship VDES transceivers will be combined with AIS into a single piece of equipment. This will have cost and installation benefits as hardware and antennas can, at times, be shared dynamically.

The design of NorSat-2 is based on SFL's flight-proven NEMO bus design. It was designed with a full complement of standard SFL electronics in addition to the payloads: AIS receiver and linearly polarized monopole antenna, VDES payload and Yagi antenna, inspection camera, and S-band feeder uplink. The external solid model of NorSat-2 is shown in Fig. 1-11.



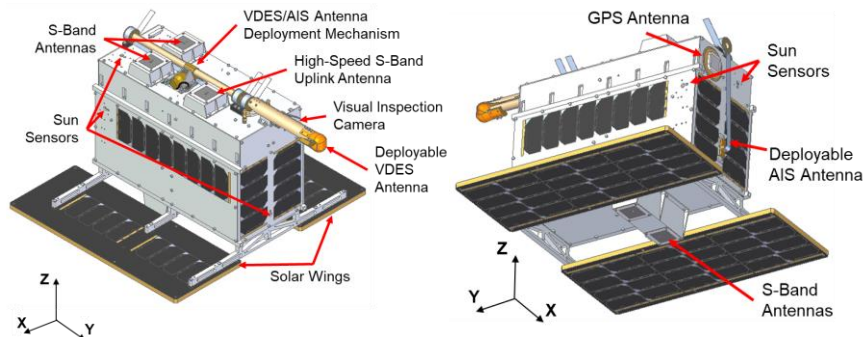

**Fig. 1-11. NorSat-2 exterior solid model.**

The VDES antenna is a high gain, directional, folded dipole 8 dBi Yagi-Uda antenna with three elements in crossed configuration. It operates in the VHF maritime band, and its phase quadrature feed scheme allows it to produce circular polarization. At  $62 \times 62 \times 73$  cm overall dimensions, its deployed geometry exceeds the total size of the NorSat-2 satellite body (Fig. 1-12).<sup>20</sup>

The deployable concept was adopted early in the design cycle, after a trade study that included a pre-deployed version of the same antenna as well as variations of helical and loop Yagi antennas. The ability to stow the antenna for launch enables a substantially lighter design that can still meet structural strength and stiffness requirements. In addition, the launch volume of the satellite is minimized, increasing compatibility with several launch vehicles and mounting configurations. The stowed VDES antenna configuration, shown in Fig. 1-12, integrates a hold-down mechanism for the AIS monopole antenna as well.



**Fig. 1-12. Stowed (left) and deployed (right) VDES and AIS antennas onboard NorSat-2 in the SFL cleanroom.**

## 1.7 Earth Stations

Two Earth stations are being used for the operation of the Norwegian AIS constellation, one located in Vardø, Norway and the other located in Svalbard,

Norway (SvalSat). The high latitude of SvalSat is well-suited to tracking polar-orbiting satellites, as the satellite is able to make contact with the station on most orbits (12-15 passes per day is readily achievable). The station is operated by Kongsberg Satellite Services (KSAT), who is responsible for scheduling contacts of all the satellites that are operated from this station. AISSat-1 and AISSat-2 were initially operated from this station until the Earth station in Vardø opened in 2015. The S-band antenna (SvalSat SG40) and UHF antenna (SvalSat SG14) used for the constellation operations are shown in Fig. 1-13 and Fig. 1-14, respectively.

Vardø, at slightly over  $70^{\circ}\text{N}$ , is further south than SvalSat and experiences a gap where the satellites cannot be tracked for several hours. However, given that this station is currently dedicated to the AIS constellation, it is somewhat easier to schedule satellite passes and results in more cost-effective operations than scheduling contacts through KSAT. The station has a 3.7 m diameter reflector with uplink and downlink capability, and a quad-Yagi UHF uplink antenna, both housed in radomes.



**Fig. 1-13. 3.0 m S-band antenna at SvalSat (SG40).**

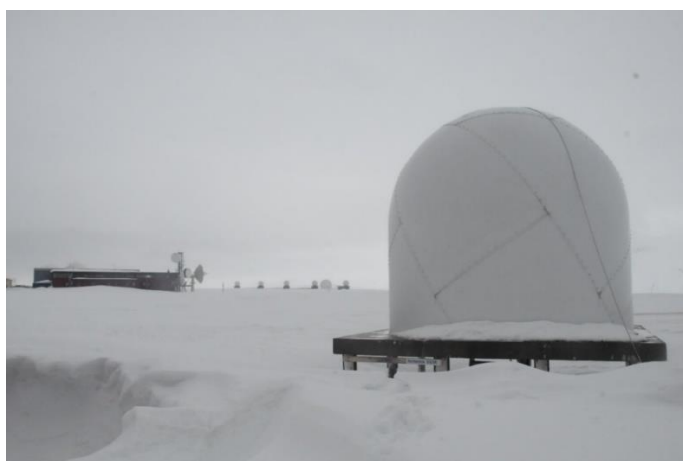

**Fig. 1-14. UHF antenna system at SvalSat (SG14).**

The first Mission Control Center (MCC) for AISSat-1 (and later also AISSat-2) was located at FFI. The MCC consisted of a control computer and a hot back-up computer, utilizing SFL software as well as software developed by FFI for planning and payload data handling. The MCC also had a server where all the AIS messages were decoded and stored for research purposes.

All communication with the satellites went through this MCC. It had direct access to the ground station on Svalbard (the only one used at the time) where it controlled the uplink UHF antenna and received the data from the KSAT S-band antenna. The access to the S-band antenna was scheduled on a weekly basis, with typically 4 or 5 accesses blocked because of conflicts with other satellites using the S-band antenna. Thus, the operations became based on weekly generated files with time-tagged commands telling the satellite what to do and when it would have access to the ground station.

Close cooperation with the NCA ensured that the MCC from day one could forward AIS messages from the satellites directly into their operational systems. During the first year, most operations concentrated on observations from the Norwegian ocean areas, with maybe one other region of interest also covered, and one day a week of global collection. Having access almost every orbit from Svalbard enabled the operators to quickly reprogram AISSat-1 to observe the oceans around Japan after the earthquake and tsunami in 2011.

The work during the first year of operations for AISSat-1 included testing optimal attitude settings as well as learning how to better optimize the operations. Improvements in software uploaded to the satellite and payload during 2011 enabled continuous global observations, removing the need to plan which areas to focus on. FFI also operated the similar NORAIS Receiver onboard the ISS. Work there together with KSX led to an improved algorithm which was uploaded to AISSat-1 in 2013, and provided a 20% improvement in number of messages received.

The MCC at FFI was operational until May 2015 when the job was handed over to Statsat AS. Satellite operations of the constellation are now done by Statsat AS on behalf of NoSA. The MCC operates autonomously for the majority of the time since the ground software will automatically send operators a health snapshot of the satellite and list of the downloaded files every contact. Satellite commanding is done primarily via time-tag, whereby a list of commands is uploaded from the ground to the HKC and when the time associated with the queued command is reached, the command is executed.

The ground software architecture for the constellation is composed of a series of specialized terminal programs that communicate with the satellite through a software multiplexer application called MUX. The MUX software suite was designed to enable multiple satellites to communicate with multiple ground stations.<sup>21</sup> The ground software programs connect to a MUX Master and they automate and script routine operations as much as possible. Furthermore, advanced mission planning software developed by Statsat AS makes commanding

of the satellites almost fully autonomous. This minimizes human intervention for repeated tasks and allows the operations team to focus on planning and analysis.

## 1.8 Operations and On-Orbit Performance

### 1.8.1 Launch and Commissioning

#### 1.8.1.1 AISSat-1 and AISSat-2

AISSat-1 launched on 12 July 2010 at 03:52 UTC on a Polar Satellite Launch Vehicle (PSLV) as a secondary payload of the PSLV-C15 mission. It separated from the launch vehicle roughly 20 minutes after launch into a 623 km sun-synchronous orbit. Initial acquisition occurred on the second Earth station contact at 06:50 UTC and the reported telemetry indicated that the batteries were fully charged and the satellite was healthy. The AIS receiver was powered on and AIS data were received the same day. Fig. 1-16 shows a map of daily global vessel observations from AISSat-1, where the color legend indicates how many times a vessel is observed over a 24-hour period.<sup>2</sup>

The commissioning activities were primarily completed by SFL over the course of four months. On 17 November 2010, AISSat-1 operations were formally handed over from SFL to FFI, thus completing the commissioning period.

Full mission success of AISSat-1 was declared on 12 July 2013, since it had demonstrated the required three years of on-orbit operations and proved that space-based AIS could be successfully done with a low-cost nanosatellite platform. AISSat-1 was no longer just a demonstration mission since the Norwegian Coastal Administration desired continuity of the data service, particularly as it was also being used for major world events, such as the Japan earthquake and tsunami in 2011. AISSat-1 therefore became an operational asset and is still in service at the time of this writing.



**Fig. 1-15. SFL launch team with AISSat-1 integrated on the PSLV-C15 rocket.**

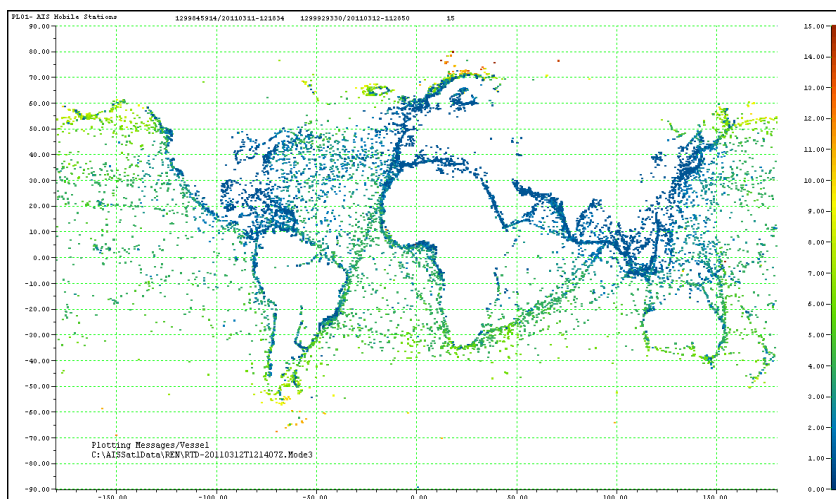

**Fig. 1-16. Global map of AIS data from AISSat-1.<sup>2</sup>**

AISSat-2 launched roughly a year later, on 8 July 2014 at 15:58 UTC, from the Baikonur Cosmodrome on a Soyuz-2.1b rocket. It separated from the Fregat upper stage at 18:32 UTC and the first AIS message was received at 19:32:25 UTC on the same day. Due to the similarity between the satellites, AISSat-2 followed an accelerated commissioning process compared to AISSat-1. All subsystems were activated within 12 hours and the satellite was commanded into three-axis control mode.

#### 1.8.1.2 NorSat-1 and NorSat-2



**Fig. 1-17. SFL launch team in Baikonur with the NorSat-1 and NorSat-2 satellites.**

NorSat-1 and NorSat-2 were launched on a Soyuz-2.1a rocket from the Baikonur Cosmodrome on 14 July 2017 at 06:36:49 UTC into a 600 km sun-synchronous orbit. Initial telemetry received from NorSat-1 and NorSat-2 indicated that the launch was successful and the satellites were healthy. A basic checkout of the core platform avionics continued over the remainder of the first contacts. The first live AIS messages were received during these contacts,

after which the AIS receivers were operated continuously in parallel with the other commissioning activities. The attitude determination and control system on both

satellites was activated and verified, and the satellites were detumbled and commanded to point in three-axis control mode.

On NorSat-2, several test images were taken with the onboard visual inspection camera in order to confirm correct gain and exposure settings prior to the deployment of the Yagi and AIS monopole antennas. The antennas were successfully deployed several days after launch, on 18 July 2017. Fig. 1-18 are images taken of the Yagi antenna by the onboard camera shortly after the command to deploy the antennas was executed.

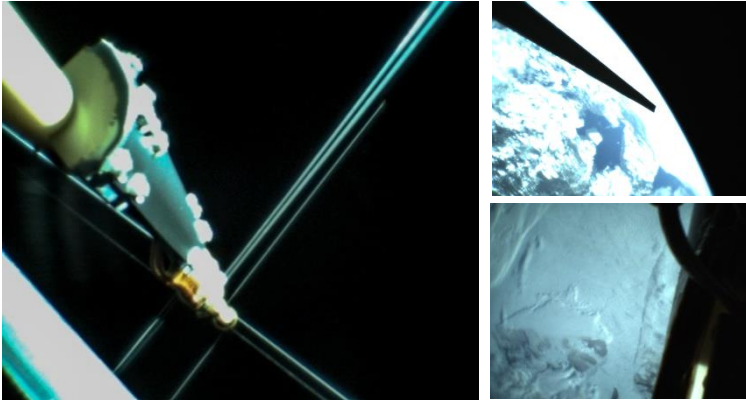

**Fig. 1-18. Image captures from the inspection camera of the deployed VDES antenna in orbit. (Images courtesy of Space Norway AS.)**

The m-NLP booms on NorSat-1 were subsequently deployed and on 28 July 2017, the final major commissioning milestone was achieved when the platform's high-fidelity sun sensor was activated and its behavior verified in the three-axis control loop. The achieved performance far outperforms the required stability of  $\pm 0.5^\circ$  ( $3\sigma$ ), as shown in the dataset in Fig. 1-19.

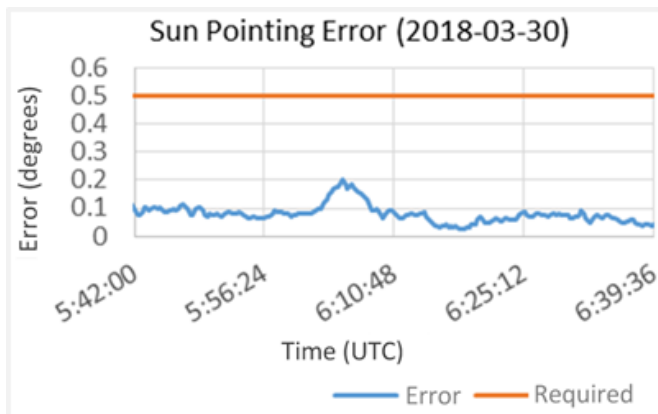

**Fig. 1-19. NorSat-1 sun pointing error.<sup>22</sup>**

## 1.8.2 AIS Performance

The AIS standard has 27 different types of messages. Message types 1, 2 and 3 are position reports that report navigational information, such as longitude and latitude, time, heading, speed, and the vessel's navigation status. Message type 27 was most recently introduced as a position report for long-range applications, which aids in space-based AIS. As the ASR 100 AIS space receiver on AISSat-1 and AISSat-2, like other first generation receivers, decodes two channels simultaneously, it cannot receive the long-range messages at the same time as the ordinary position report. NorSat-1 and NorSat-2 have four channels and the capability to receive this AIS message type. This aids in detecting a greater number of messages in high-traffic areas and also a greater number of ships (i.e., MMSI number, which is the unique number associated with the vessel's AIS transponder).

With the launch of NorSat-1 and NorSat-2 in 2017, the maritime picture improved significantly. The ASR x50 receivers on NorSat-1 and NorSat-2 are capable of detecting more AIS messages than the ASR 100 flown on AISSat-1 and AISSat-2. The two NorSats each collect about 1.3 million messages from 36,000 ships per day, which is 2.5 times more than the number of messages collected from AISSat-1. Table 1-2 shows the performance of the constellation over the course of 24 hours taken on 6 August 2017, shortly after the launch of the NorSat-1 and NorSat-2 satellites. Furthermore, Fig. 1-20 shows a comparison of the number of AIS messages received from AISSat-1, NorSat-1, and all satellites combined.

**Table 1-2. Global performance of the constellation, including the NORAIS-2 Receiver installed on the ISS. Data taken over 24 hours on 6 August 2017.<sup>23</sup>**

| Satellite | Message Type 1-3 |            | Message Type 27 |            |
|-----------|------------------|------------|-----------------|------------|
|           | # of Messages    | # of MMSIs | # of Messages   | # of MMSIs |
| AISSat-1  | 382,080          | 24,607     | -               | -          |
| AISSat-2  | 514,276          | 25,076     | -               | -          |
| NORAIS-2  | 564,106          | 28,837     | 52,174          | 11,734     |
| NorSat-1  | 1,304,814        | 36,352     | 118,914         | 13,287     |
| NorSat-2  | 1,309,345        | 36,312     | 52,133          | 11,908     |
| Total     | 4,074,621        | 43,895     | 223,221         | 13,521     |

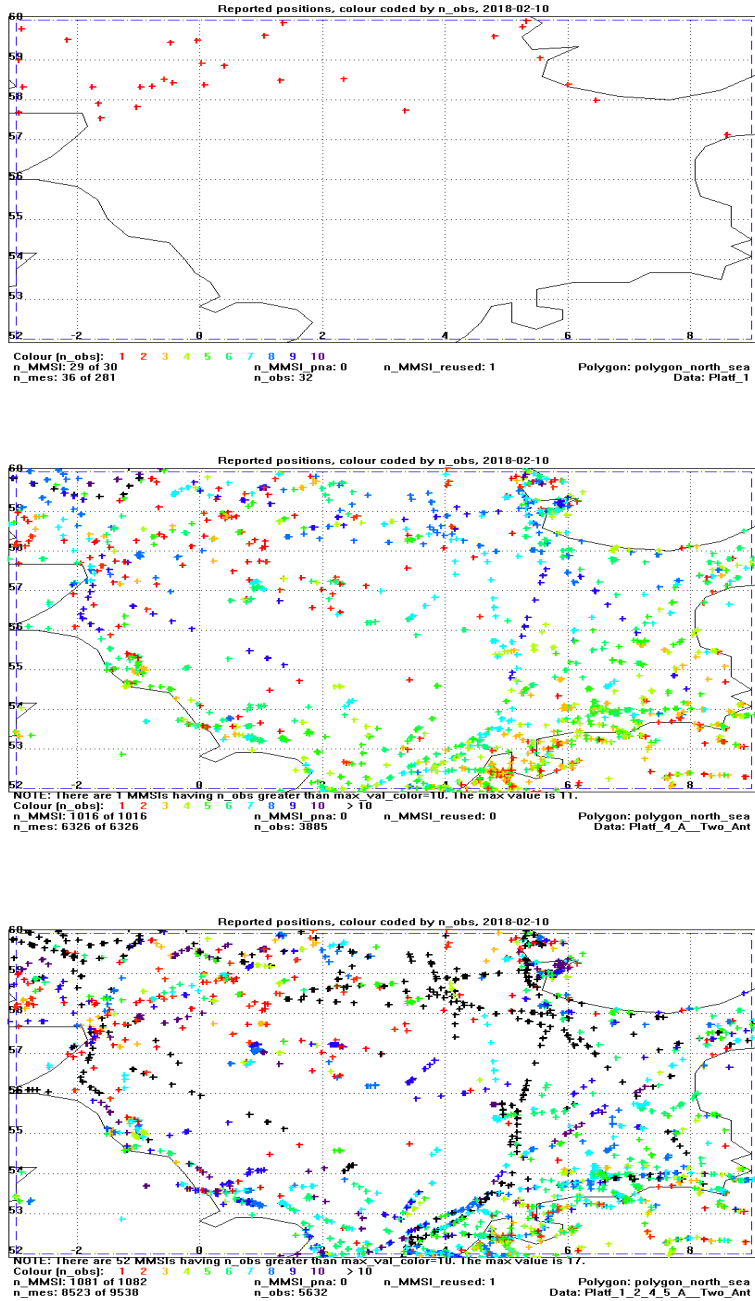
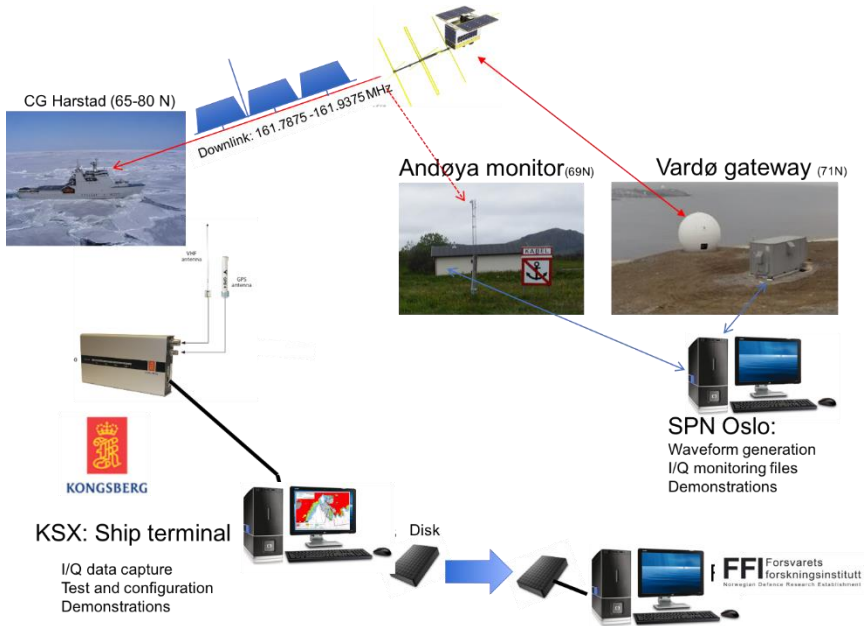

**Fig. 1-20. Ship positions in the North Sea colored by the number of observations per ship, where red is one and black is greater than 10. AISat-1 (top), NorSat-1 (middle), all four satellites (bottom).<sup>8</sup>**



### 1.8.3 VDES Test Campaign

To assess the technical characteristics of the ITU-R M.2092 as well as the performance of the VDE-SAT test payload on NorSat-2, transmissions were conducted from the payload to a ship terminal installed on a Norwegian coast guard vessel and to a fixed terminal in Andøya, Norway.<sup>24</sup> Fig. 1-21 shows the experimental setup for the campaign. The payload is able to transmit on one or multiple carriers in the downlink frequency band with a total output power of 28 dBm (at 1 dB compression). A continuous-wave (CW) beacon signal was transmitted for 12 s on, 12 s off, three periods per minute. The 12 s gaps in between are for AIS reception (Fig. 1-22).



**Fig. 1-21. Setup of the NorSat-2 downlink verification campaign. (Image courtesy of Space Norway AS.)**

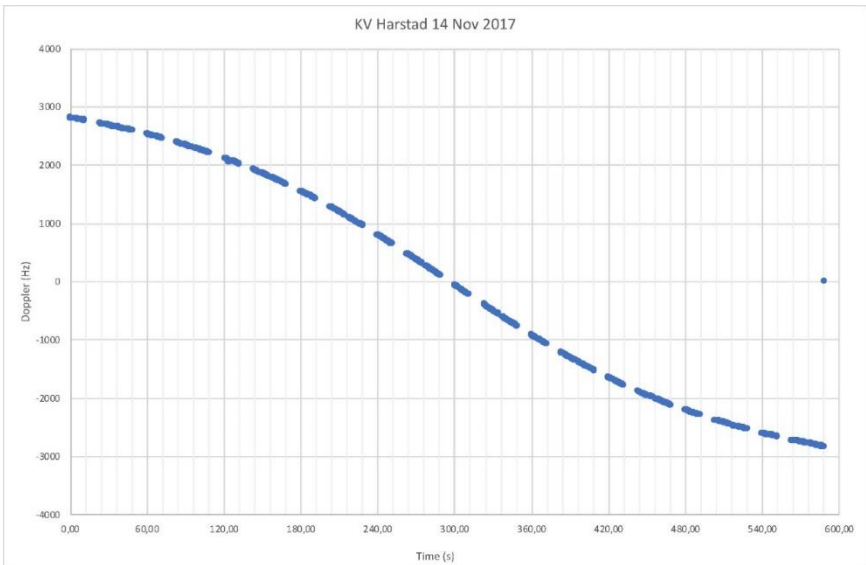
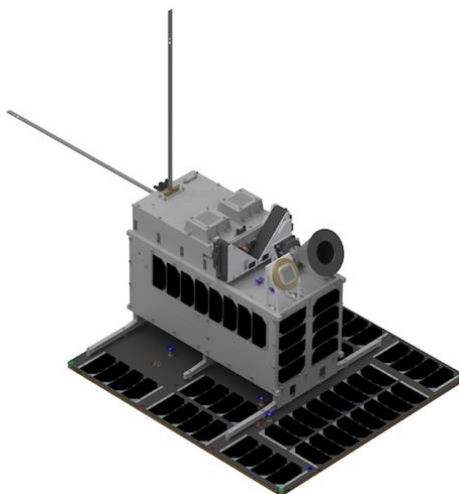

**Fig. 1-22. Doppler frequency shift for a pass on 14 November 2017 measured onboard the KV Harstad vessel.<sup>25</sup>**

### 1.9 Next on the Pad: NorSat-3

The next satellite to be added to the constellation is NorSat-3. NorSat-3 follows from the success of its NorSat predecessors in carrying an ASR x50 AIS receiver in addition to an experimental auxiliary payload, which is a Navigation Radar Detector (NRD). The IMO standard requires that all ships over 300 metric tons carry navigation radar. The NRD payload detects and analyzes the signals emitted from ships, which allows it to verify the AIS data or detect ships that have their AIS transmitter turned off, thus completing the maritime picture.

NorSat-3 is based on the NEMO platform and its design draws heritage from the NorSat-1 and NorSat-2 missions. Rather than two wings, it has a single, larger composite panel that is needed to support the antenna array for the NRD payload and the primary solar array for the spacecraft. It has the standard suite of ADCS hardware and also carries a star tracker for precision pointing required for the NRD payload. Fig. 1-23 shows the external solid model of the NorSat-3 spacecraft.



**Fig. 1-23. NorSat-3 external solid model.**

The NRD payload consists of an RF front end, an interface board, and a data processing board integrated into a single unit. This is connected to a four-module  $56 \times 62$  cm antenna plate with a beamwidth of  $10^\circ$ . Operation of the NRD payload will initially occur over the high north. When the antenna is pointed at the horizon, it covers an elliptical area on the Earth that is 1400 km long by 450 km wide (Fig. 1-24).<sup>8</sup> Using phase discrimination and advanced signal processing, the position of the vessels with navigation radars is determined with an accuracy on the order of 10 km CEP (Circular Error Probable). Comparison of the received signals from the NRD payload and the AIS receiver will provide a more complete picture of maritime traffic and address problems of missing or manipulated AIS data.

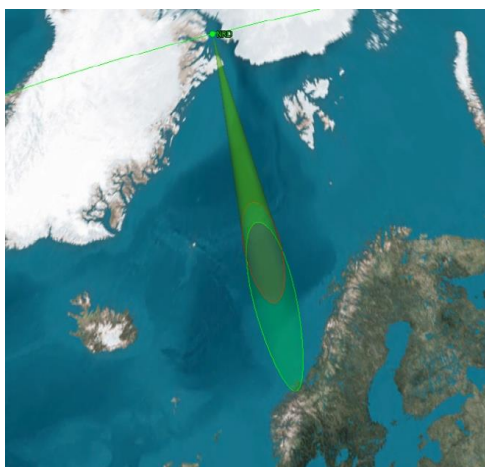

**Fig. 1-24. NRD payload coverage during a typical Earth station pass, showing the 1400 km long by 450 km wide elliptical area. (Image courtesy of FFI.)**

## 1.10 Conclusion

From the start of the AISSat-1 mission in 2007 to the ongoing design and development of NorSat-3 today, the Norwegian AIS small satellite program has demonstrated that a high degree of reliability can be achieved with low-cost, high-performance nano- and microsattelites. Initially a demonstration mission, AISSat-1, and the other small satellites have become operational assets for a sovereign nation, which is the first step towards launching more operational assets in the future. The satellites have provided valuable data to Norwegian authorities. Moreover, they are providing near real-time coverage in the ocean areas of interest around Norway. Employing a small satellite constellation over a single, larger satellite assures robustness against failure and results in significantly shorter satellite development times. The achieved on-orbit performance of AISSat-1, AISSat-2, NorSat-1, and NorSat-2 is a significant accomplishment for Norway and SFL alike, as they are both pushing the envelope of the missions that can be achieved with small satellites.

## 1.11 Acknowledgements

The authors would like to thank their colleagues from the Norwegian Space Agency, the Norwegian Coastal Administration, the Norwegian Defence Research Establishment, Kongsberg Seatex, Statsat AS, Physical Meteorological Observatory in Davos/World Radiation Center, University of Oslo, and Space Norway AS. The authors would also like to thank the work done by Sean Hum and his lab at the University of Toronto for the radio-frequency design of the NorSat-2 antenna.

## 1.12 References

<sup>1</sup> T. Eriksen, G. Høye, B. Narheim, and B. Jensløyken Meland “Maritime Traffic Monitoring Using A Space-Based AIS Receiver”, *Acta Astronautica* 58, issue 10, 537 – 549 (2006).

<sup>2</sup> B. T. Narheim, Ø. Hølleren, Ø. Olsen, R. Olsen, H. Rosshaug, A. M. Beattie, D. D. Kekez, and R. E. Zee, “AISSat-1 Early Results,” Paper SSC11-III-6 presented at the 25<sup>th</sup> Annual AIAA/USU Conference on Small Satellites, Aug. 2011.

<sup>3</sup> J. S. Cain and E. Meger, “Space-Based AIS: Contributing to Global Safety and Security,” presented at the ISU 13<sup>th</sup> Annual Symposium – ‘Space for a Safe and Secure World’, Feb. 2009.

<sup>4</sup> T. Eriksen, B. Narheim, G. Høye, and T. Wahl, “New micro-satellite based concept for monitoring of maritime traffic by navigation radar detection,” presented at the 8<sup>th</sup> International Symposium on Remote Sensing, Sept. 2001.

<sup>5</sup> J. P. Johnsen, “Creating political spaces at sea – governmentalisation and governability in Norwegian fisheries,” *Maritime Studies* 16:18 (2017).

<sup>6</sup> International Maritime Organisation, International Convention for the Safety of Life at Sea “SOLAS” (1974), Chapter V “Safety of Navigation”, Regulation 19.

<sup>7</sup> Recommendation ITU-R M.1371-5, Technical characteristics for an automatic identification system using time division multiple access in the VHF maritime mobile frequency band, International Telecommunication Union, Geneva, 2014.

<sup>8</sup> J. Harr, T. Jones, B. N. Andersen, T. Eriksen, A. N. Skauen, K. Svenes, E. V. Blindheim, I. Spydevold, A. Beattie, L. M. Bradbury, B. Cotten, D. Kekez, P. Mehradnia, R. E. Zee, and F. Storesund, “Microsatellites for Maritime Surveillance – an update on the Norwegian Smallsat Program,” Paper IAC-18,B4,4,2,x45204 presented at the 69<sup>th</sup> International Astronautical Congress (IAC), Oct. 2018.

<sup>9</sup> H. Pablo, G. N. Whittaker, A. Popowicz, S. M. Mochnacki, R. Kuschnig, C. C. Grant, A. F. J. Moffat, S. M. Rucinski, J. M. Matthews, A. Schwarzenberg-Czerny, G. Handler, W. W. Weiss, D. Baade, G. A. Wade, E. Zocłńska, T. Ramiaramanantsoa, M. Unterberger, K. Zwintz, A. Pigulski, J. Rowe, O. Koudelka, P. Orleański, A. Pamyatnykh, C. Neiner, R. Wawrzaszek, G. Marcinişzyn, P. Romano, G. Woźniak, T. Zawistowski, and R. E. Zee, “The BRITE Constellation Nanosatellite Mission: Testing, Commissioning, and Operations,” *Publications of the Astronomical Society of the Pacific*, 128:125001 (2016).

<sup>10</sup> G. Bonin, N. Roth, S. Armitage, J. Newman, B. Risi, and R. E. Zee, “CanX-4 and CanX-5 Precision Formation Flight: Mission Accomplished!” Paper SSC15-I-4 presented at the 29<sup>th</sup> Annual AIAA/USU Conference on Small Satellites, Aug. 2015.

<sup>11</sup> K. Sarda, A. Beattie, D. D. Kekez, and R. E. Zee, “In-Flight Experience of the High Performance Attitude Determination and Control System of the Generic Nanosatellite Bus,” presented at the 4S Symposium 2012, Jun. 2012.

<sup>12</sup> G. Bonin, D. Sinclair, and R. E. Zee, “Peak Power Tracking on a Nanosatellite Scale: The Design and Implementation of Digital Power Electronics on the SFL Generic Nanosatellite Bus,” Paper SSC09-XI-9 presented at the 23<sup>rd</sup> Annual AIAA/USU Conference on Small Satellites,” Aug. 2009.

<sup>13</sup> F. M. Pranajaya and R. E. Zee, “The NEMO Bus: A Third Generation High Performance Nanosatellite for Earth Monitoring and Observation,” Paper SSC10-VI-8 presented at the 24<sup>th</sup> Annual AIAA/USU Conference on Small Satellites, Aug. 2010.

<sup>14</sup> H. Hoang, L.B.N. Clausen, K. Røed, T.A. Bekkeng, E. Trondsen, B. Lybekk, H. Strøm, D.M. Bang-Hauge, A. Pedersen, A. Spicher, J.I. Moen, “The Multi-Needle Langmuir Probe System on Board NorSat-1,” *Space Science Reviews*, 214:75 (2018).

<sup>15</sup> B. Walter, P. Levesque, G. Kopp, B. Andersen, I. Beck, W. Finsterle, M. Gyo, K. Heuerman, S. Koller, N. Mingard, A. R. Oliva, D. Piffner, R. Soder, M. Spescha, M. Suter, and W. Schmutz, “The CLARA/NORSAT-1 solar absolute radiometer: instrument design, characterization and calibration,” *Metrologia* 54, 674-682 (2017).

<sup>16</sup> T. Eriksen, L. E. Bråten, H. C. Haugli, and F. A. S. Storesund, “VDE-SAT – A new maritime communications system,” presented at the 4S Symposium 2016, Jun. 2016.

<sup>17</sup> ITU Radiocommunication Sector, “Technical characteristics for a VHF data exchange system in the VHF maritime mobile band,” International Telecommunication Union, Geneva, Switzerland, ITU-R M.2092-0, 2015.

<sup>18</sup> Resolution 360 (REV.WRC-15), “Consideration of regulatory provisions and spectrum allocations to the maritime mobile-satellite service to enable the satellite component of the VHF Data Exchange System and enhanced maritime radiocommunication,” World Radiocommunication Conference, Geneva, 2015.

<sup>19</sup> H. C. Haugli and L. Løge, “The Challenge of VDES in Space,” presented at VDES Conference 2017, 2017.

<sup>20</sup> L. M. Bradbury, D. Diaconu, S. Molgat Laurin, A. M. Beattie, C. Ma, I. S. Spydevold, H. C. Haugli, R. E. Zee, J. Harr, F. Udnæs, “NORSAT-2: Enabling Advanced Maritime Communication with VDES,” Paper IAC-17.B2.7.4x38140 presented at the 68<sup>th</sup> International Astronautical Congress (IAC), Sept. 2017.

<sup>21</sup> A. M. Beattie, Daniel D. Kekez, A. Walker, R. E. Zee, “Evolution of Multi-Mission Nanosatellite Ground Segment Operations,” presented at the SpaceOps 2012 Conference, Jun. 2012.

<sup>22</sup> P. Mehradnia, A. M. Beattie, D. D. Kekez, R. E. Zee, B. Walter, S. Koller, D. Pfiffner, W. Finsterle, W. Schmutz, H. M. Hoang, E. Trondsen, B. Lybekk, L. B. N. Clausen, J. I. Moen, F. A. S. Storesund, B. T. Narheim, F. Sem-Jacobsen, J. Harr, M. Osmundsen, B. N. Andersen, “NorSat-1: Commissioning and On-Orbit Performance of Norway’s First Scientific Microsatellite,” presented at the 4S Symposium 2018, May 2018.

<sup>23</sup> T. Eriksen, Ø. Hellenen, A. N. Skauen, F. A. S. Storesund, A. Bjørnevik, H. Åsheim, E. V. Blindheim, J. Harr, “In-orbit AIS performance of the Norwegian microsatellites NorSat-1 and NorSat-2,” presented at the 4S Symposium 2018, May 2018.

<sup>24</sup> T. Eriksen, L. E. Bråten, A. N. Skauen, H. C. Haugli, L. Løge, A. Bjørnevik, F. A. S. Storesund, N. S. Alagha, “VDE-SAT – Preliminary verification results for proposed satellite component of new maritime communications system,” presented at the 4S Symposium 2018, May 2018.

<sup>25</sup> I. Spydevold, personal e-mail (May 25, 2018).